

**1530**

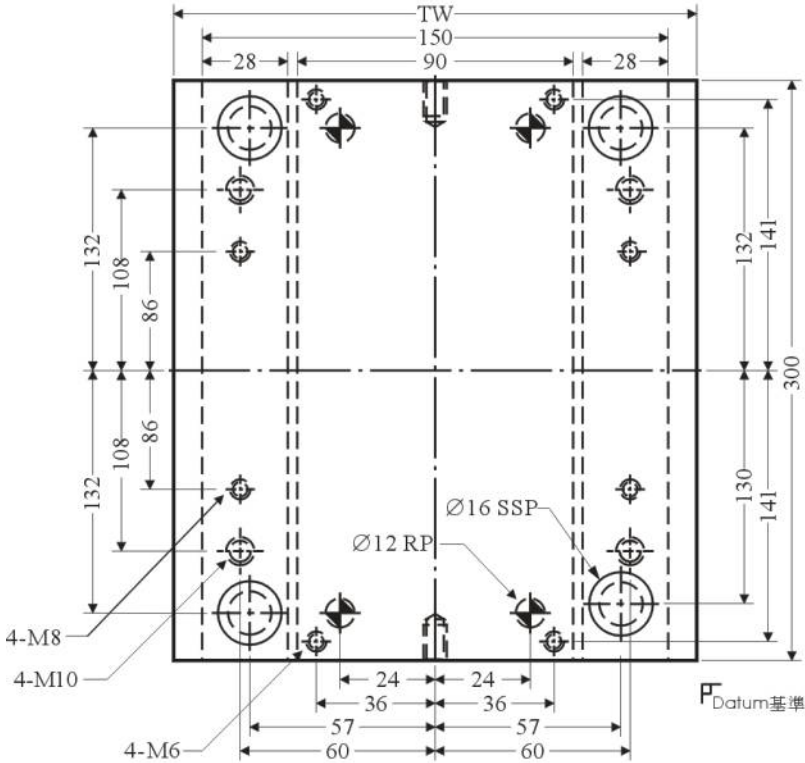

底面板闊度	TW
工字模 I TYPE	200
直身模 H TYPE	150

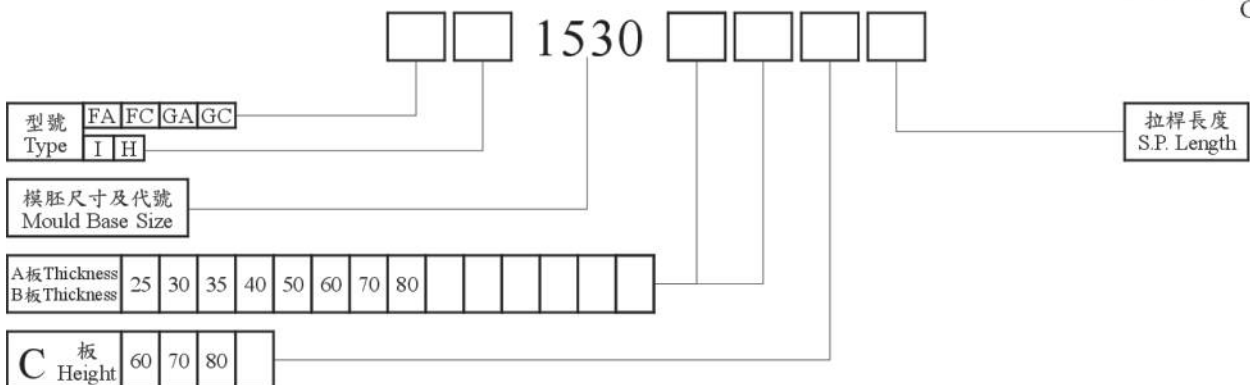
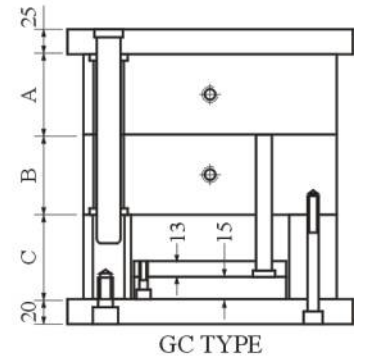
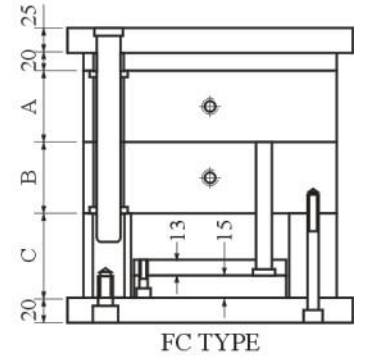
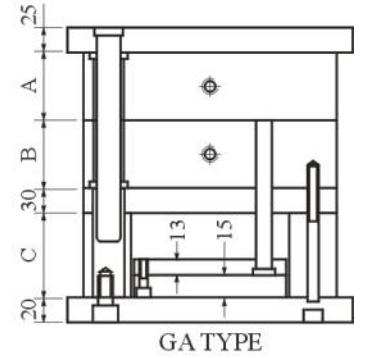
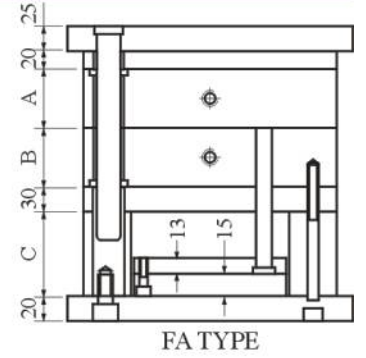

※ 吊模孔尺寸詳見〈吊模螺絲孔規格〉